

# 8P8C EZ Category 5e Module

## PRODUCT SPECIFICATION

### Package includes:

- A. 8P8C EZ Category 5e Module, 1 pc
- B. Termination Cap, 1 pc
- C. Installation Instructions, 1 sheet

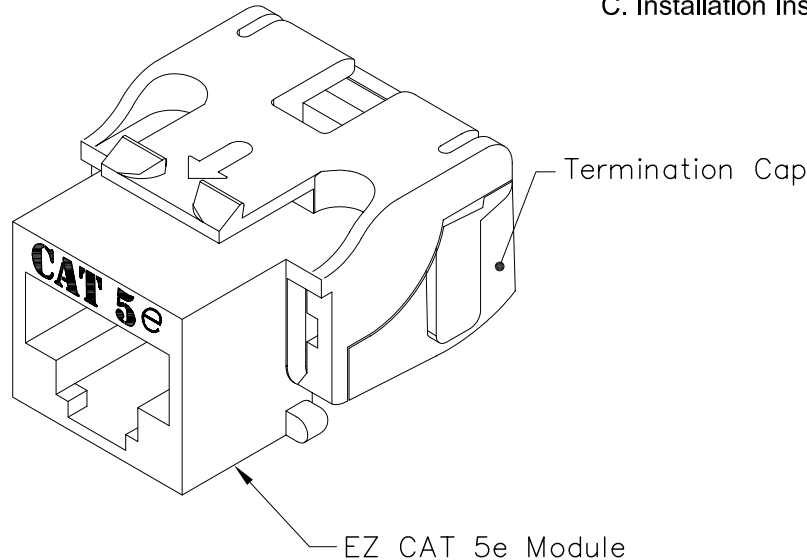

### Features and Benefits:

- CAT 5e rated connectors provide excellent performance for data networks requiring maximum speed and bandwidth
- PCB technology provides maximum performance and superior signal quality
- Enhanced crosstalk cancellation reduces return loss and improves performance by rejecting noise and unwanted signals
- Exceeds ANSI/TIA/EIA-568-B.2 Category 5e connecting hardware requirements
- Engineered to provide 110 IDC termination reducing installation time
- One piece termination cap allows for a quick and easy termination
- Includes an integrated TIA-568A/B color wiring diagram
- Backwards compatible to all lower rated category components
- Compatible with all IC107 faceplates, inserts, surface mount boxes, and blank patch panels
- Compatible with all IC108 furniture faceplates, bezels, and surface mount boxes
- Used with ICC Category 5e ICPCS5 and ICPCS9 series patch cords and 110 punch down tool ICACSPDT00
- Available in almond, black, blue, gray, green, ivory, orange, purple, red, white, and yellow
- Installation instructions #MSR-0399-2 included
- UL listed

### MODULE, CAT 5E, EZ

ITEM NO.	IC1078E5XX	REV.	A	
DWG NO.	PS1078E500	PAGE NO.	1	

CUSTOMER CARE / TECHNICAL SUPPORT \* CSR@ICC.COM / 888-ASK-4-ICC (275-4422) \* 16800 Edwards Road, Cerritos, CA 90703 \* Phone 562-356-3111 \* Fax 562-356-3100 \* www.icc.com

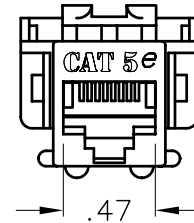
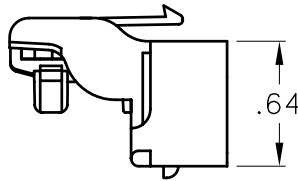
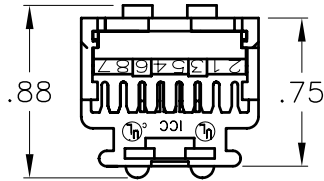
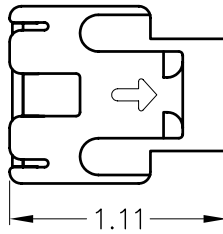

T568B WIRING		T568A WIRING	
2	ORANGE	2	GREEN
1	WHITE/ORANGE	1	WHITE/GREEN
3	WHITE/GREEN	3	WHITE/ORANGE
5	WHITE/BLUE	5	WHITE/BLUE
4	BLUE	4	BLUE
6	GREEN	6	ORANGE
8	BROWN	8	BROWN
7	WHITE/BROWN	7	WHITE/BROWN

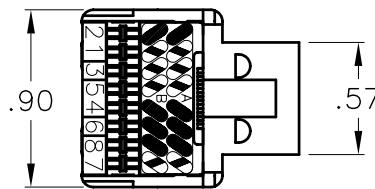

**NOTE: UNLESS OTHERWISE SPECIFIED**

**1. CAT 5E MODULE:**

**A. ELECTRICAL:**

- CURRENT RATING: 1.5 AMPS
- INSULATION RESISTANCE: 500 MOHMS MIN
- CONTACT RESISTANCE: 20 MOHMS MAX
- DC RESISTANCE: 0.1 OHM MAX
- TRANSMISSION PERFORMANCE EXCEEDS CATEGORY 5E CONNECTING HARDWARE REQUIREMENTS SPECIFIED IN TIA/EIA-568-B.2 WHEN USED WITH COMPATIBLE HORIZONTAL CABLE

CATEGORY 5e CONNECTING HARDWARE REQUIREMENTS										
FREQUENCY (MHz)	1.0	4.0	8.0	10.0	16.0	20.0	25.0	31.25	62.5	100
NEXT LOSS (db)	65.0	65.0	64.9	63.0	58.9	57.0	55.0	53.1	47.1	43.0
FEXT LOSS (db)	75.1	63.1	57.0	55.1	51.0	49.1	47.1	45.2	39.2	35.1
RETURN LOSS (db)	35.0	35.0	35.0	35.0	35.0	34.0	32.0	30.1	24.1	20.0
INSERTION LOSS(db)	0.10	0.10	0.10	0.10	0.20	0.20	0.20	0.20	0.30	0.40

**B. MECHANICAL:**

- PLUG INSERTION LIFE: 750 CYCLES MIN
- PLUG & JACK CONTACT FORCE: 100 GRAMS MIN USING FCC APPROVED PLUG
- PLUG RETENTION FORCE: 30 LBS MIN
- TEMPERATURE: -40° TO 150° F (-40° TO 68° C)

**C. PHYSICALS:**

- HOUSING: ABS, UL 94V-0
- JACK WIRING: 50 MICRO INCHES OF GOLD OVER 100 INCHES OF NICKEL
- CONNECTOR: INSULATION DISPLACEMENT CONNECTOR (IDC)  
ACCEPTS 22~24 AWG SOLID WIRE

**D. COLORS: XX: AL-ALMOND, BK-BLACK, BL-BLUE, GN-GREEN, GY-GRAY, IV-IVORY, OR-ORANGE, PR-PURPLE, RD-RED, WH-WHITE, & YL-YELLOW**

**2. TERMINATION CAP:**

- A. MATERIAL: PC, UL 94V-0
- B. COLOR: LIGHT BLUE



**MODULE, CAT 5E, EZ**

ITEM NO.	IC1078E5XX	REV.	A	
DWG NO.	PS1078E500	PAGE NO.	2	

CUSTOMER CARE / TECHNICAL SUPPORT \* CSR@ICC.COM / 888-ASK-4-ICC (275-4422) \* 16800 Edwards Road, Cerritos, CA 90703 \* Phone 562-356-3111 \* Fax 562-356-3100 \* www.icc.com